

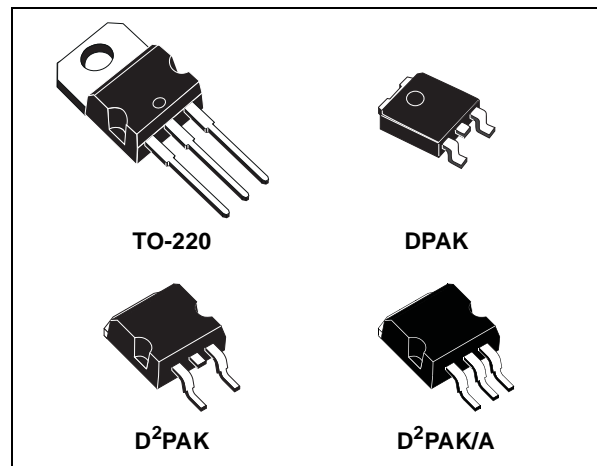

LD1086 SERIES

1.5A LOW DROP POSITIVE VOLTAGE REGULATOR ADJUSTABLE AND FIXED

- TYPICAL DROPOUT 1.3V AT 1.5A
- THREE TERMINAL ADJUSTABLE OR FIXED OUTPUT VOLTAGE 1.5V, 1.8V, 2.5V, 2.85V, 3.3V, 3.6V, 5V, 8V, 9V, 12V.
- GUARANTEED OUTPUT CURRENT UP TO 1.5A
- OUTPUT TOLERANCE $\pm 1\%$ AT 25°C AND $\pm 2\%$ IN FULL TEMPERATURE RANGE
- INTERNAL POWER AND THERMAL LIMIT
- WIDE OPERATING TEMPERATURE RANGE -40°C TO 125°C
- PACKAGE AVAILABLE: TO-220, D²PAK, D²PAK/A, DPAK
- PINOUT COMPATIBILITY WITH STANDARD ADJUSTABLE VREG



DESCRIPTION

The LD1086 is a LOW DROP Voltage Regulator able to provide up to 1.5A of Output Current. Dropout is guaranteed at a maximum of 1.2V at the maximum output current, decreasing at lower loads. The LD1086 is pin to pin compatible with the older 3-terminal adjustable regulators, but has better performances in term of drop and output tolerance.

A 2.85V output version is suitable for SCSI-2 active termination. Unlike PNP regulators, where a part of the output current is wasted as quiescent current, the LD1086 quiescent current flows into the load, so increase efficiency. Only a 10 μ F minimum capacitor is need for stability. The device is supplied in TO-220, D²PAK, D²PAK/A and DPAK. On chip trimming allows the regulator to reach a very tight output voltage tolerance, within $\pm 1\%$ at 25°C.

Table 1: Order Codes

TO-220	D ² PAK (*)	D ² PAK/A (*)	DPAK (*)	OUTPUT VOLTAGE
LD1086V15	LD1086D2T15	LD1086D2M15	LD1086DT15	1.5 V
LD1086V18	LD1086D2T18	LD1086D2M18	LD1086DT18	1.8 V
LD1086V25	LD1086D2T25	LD1086D2M25	LD1086DT25	2.5 V
LD1086V28	LD1086D2T28	LD1086D2M28	LD1086DT28	2.85 V
LD1086V33	LD1086D2T33	LD1086D2M33	LD1086DT33	3.3 V
LD1086V36	LD1086D2T36	LD1086D2M36	LD1086DT36	3.6 V
LD1086V50	LD1086D2T50	LD1086D2M50	LD1086DT50	5.0 V
LD1086V80	LD1086D2T80	LD1086D2M80	LD1086DT80	8.0 V
LD1086V90	LD1086D2T90	LD1086D2M90	LD1086DT90	9.0 V
LD1086V12	LD1086D2T12	LD1086D2M12	LD1086DT12	12.0 V
LD1086V	LD1086D2T	LD1086D2M	LD1086DT	ADJ

(*) Available in Tape & Reel with the suffix "TR".

LD1086 SERIES

Figure 1: Pin Connection (top view)

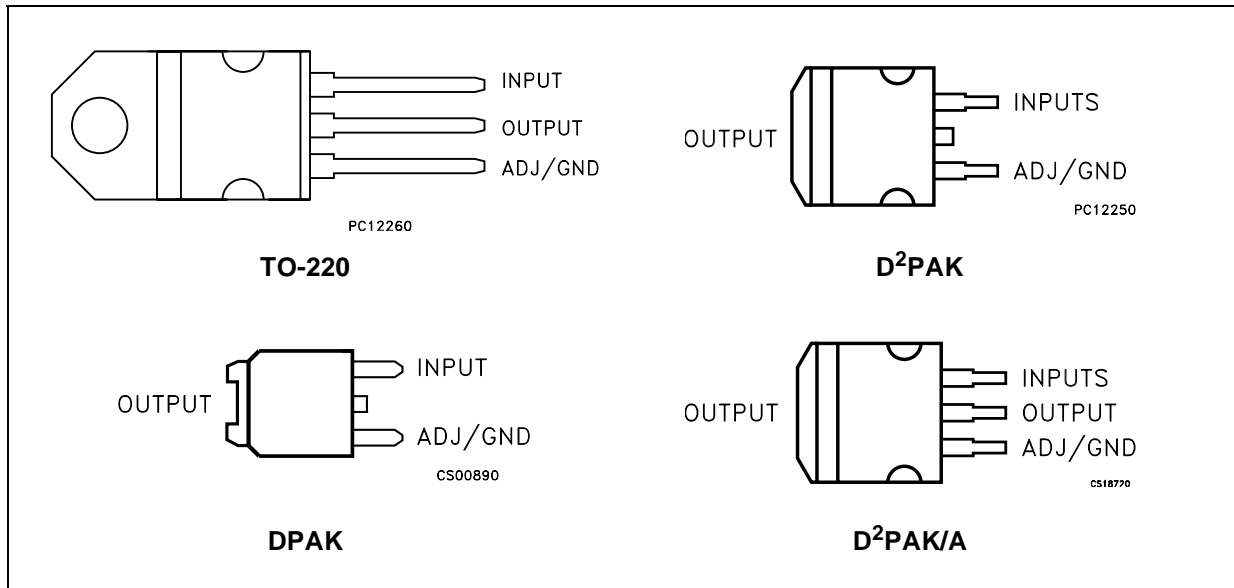

Table 2: Absolute Maximum Ratings

Symbol	Parameter	Value	Unit
V_I	DC Input Voltage	30	V
I_O	Output Current	Internally Limited	mA
P_D	Power Dissipation	Internally Limited	mW
T_{stg}	Storage Temperature Range	-55 to +150	°C
T_{op}	Operating Junction Temperature Range	-40 to +125	°C

Absolute Maximum Ratings are those values beyond which damage to the device may occur. Functional operation under these condition is not implied.

Table 3: Thermal Data

Symbol	Parameter	TO-220	D ² PAK	DPAK	Unit
$R_{thj-case}$	Thermal Resistance Junction-case	3	3	8	°C/W
$R_{thj-amb}$	Thermal Resistance Junction-ambient	50	62.5		°C/W

Figure 2: Application Circuits

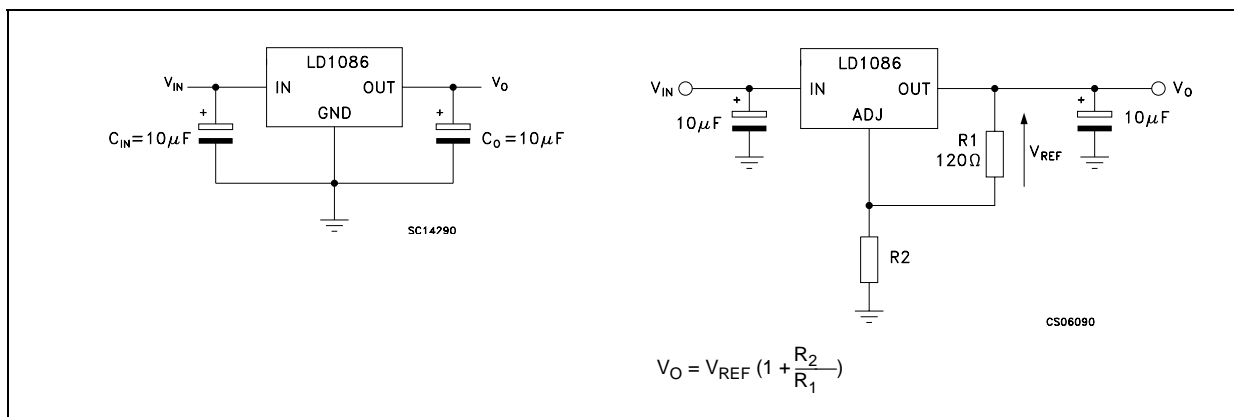

Figure 3: Schematic Diagram

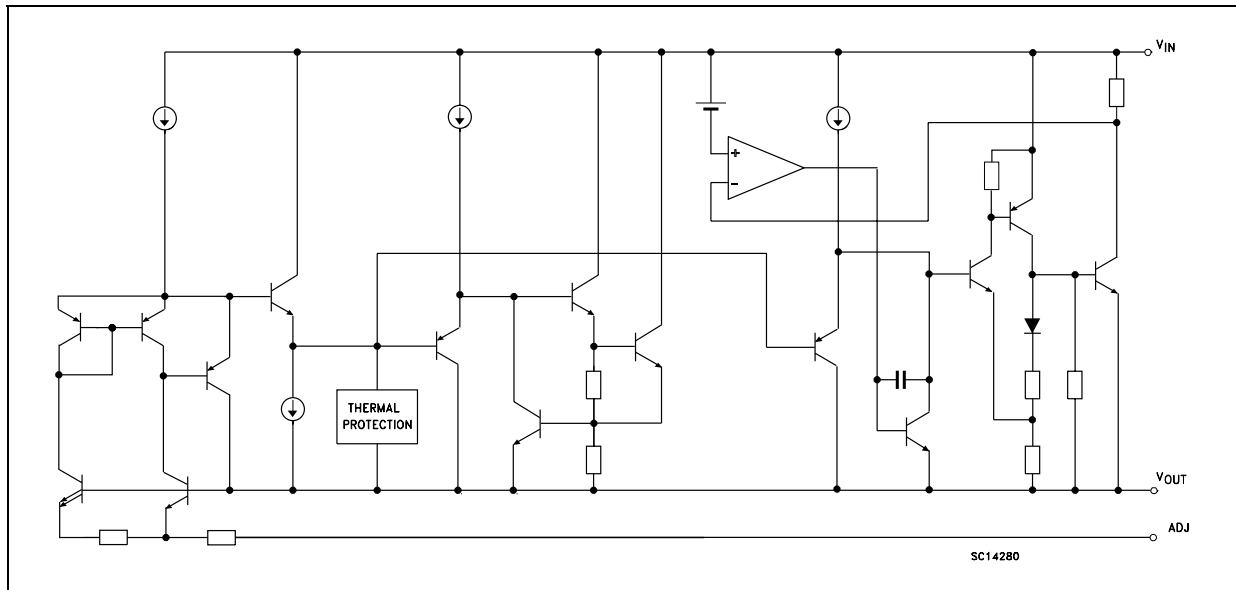

Table 4: Electrical Characteristics Of LD1086#15 ($V_I=4.5V$, $C_I = C_O=10\mu F$, $T_A = -40$ to $125^\circ C$, unless otherwise specified.)

Symbol	Parameter	Test Conditions	Min.	Typ.	Max.	Unit
V_O	Output Voltage (note 1)	$I_O = 0 \text{ mA}$ $T_J = 25^\circ C$	1.485	1.5	1.515	V
		$I_O = 0$ to $1.5A$ $V_I = 3.4$ to $30V$	1.47	1.5	1.53	V
ΔV_O	Line Regulation	$I_O = 0 \text{ mA}$ $V_I = 3.1$ to $18V$ $T_J = 25^\circ C$		0.2	4	mV
		$I_O = 0 \text{ mA}$ $V_I = 3.1$ to $15V$		0.4	4	mV
ΔV_O	Load Regulation	$I_O = 0$ to $1.5A$ $T_J = 25^\circ C$		0.5	8	mV
		$I_O = 0$ to $1.5A$		1	16	mV
V_d	Dropout Voltage	$I_O = 1.5A$		1.3	1.5	V
I_q	Quiescent Current	$V_I \leq 30V$		5	10	mA
I_{sc}	Short Circuit Current	$V_I - V_O = 5V$	1.5	2		A
		$V_I - V_O = 25V$	0.05	0.02		A
	Thermal Regulation	$T_A = 25^\circ C$, 30ms pulse		0.01	0.04	%/W
SVR	Supply Voltage Rejection	$f = 120 \text{ Hz}$, $C_O = 25 \mu F$, $I_O = 1.5A$ $V_I = 6.5 \pm 3V$	60	82		dB
eN	RMS Output Noise Voltage (% of V_O)	$T_A = 25^\circ C$ $f = 10\text{Hz}$ to 10KHz		0.003		%
S	Temperature Stability			0.5		%
S	Long Term Stability	$T_A = 125^\circ C$ 1000Hrs		0.5		%

NOTE 1: See short-circuit current curve for available output current at fixed dropout.

LD1086 SERIES

Table 5: Electrical Characteristics Of LD1086#18 ($V_I=4.8V$, $C_I = C_O=10\mu F$, $T_A = -40$ to $125^\circ C$, unless otherwise specified.)

Symbol	Parameter	Test Conditions	Min.	Typ.	Max.	Unit
V_O	Output Voltage (note 1)	$I_O = 0 \text{ mA}$ $T_J = 25^\circ C$	1.782	1.8	1.818	V
		$I_O = 0$ to $1.5A$ $V_I = 3.4$ to $30V$	1.764	1.8	1.836	V
ΔV_O	Line Regulation	$I_O = 0 \text{ mA}$ $V_I = 3.4$ to $18V$ $T_J = 25^\circ C$		0.2	4	mV
		$I_O = 0 \text{ mA}$ $V_I = 3.4$ to $15V$		0.4	4	mV
ΔV_O	Load Regulation	$I_O = 0$ to $1.5A$ $T_J = 25^\circ C$		0.5	8	mV
		$I_O = 0$ to $1.5A$		1	16	mV
V_d	Dropout Voltage	$I_O = 1.5A$		1.3	1.5	V
I_q	Quiescent Current	$V_I \leq 30V$		5	10	mA
I_{sc}	Short Circuit Current	$V_I - V_O = 5V$	1.5	2		A
		$V_I - V_O = 25V$	0.05	0.02		A
	Thermal Regulation	$T_A = 25^\circ C$, 30ms pulse		0.01	0.04	%/W
SVR	Supply Voltage Rejection	$f = 120 \text{ Hz}$, $C_O = 25 \mu F$, $I_O = 1.5A$ $V_I = 6.8 \pm 3V$	60	82		dB
eN	RMS Output Noise Voltage (% of V_O)	$T_A = 25^\circ C$ $f = 10\text{Hz}$ to 10KHz		0.003		%
S	Temperature Stability			0.5		%
S	Long Term Stability	$T_A = 125^\circ C$ 1000Hrs		0.5		%

NOTE 1: See short-circuit current curve for available output current at fixed dropout.

Table 6: Electrical Characteristics Of LD1086#25 ($V_I=5.5V$, $C_I = C_O=10\mu F$, $T_A = -40$ to $125^\circ C$, unless otherwise specified.)

Symbol	Parameter	Test Conditions	Min.	Typ.	Max.	Unit
V_O	Output Voltage (note 1)	$I_O = 0 \text{ mA}$ $T_J = 25^\circ C$	2.475	2.5	2.525	V
		$I_O = 0$ to $1.5A$ $V_I = 4.1$ to $30V$	2.45	2.5	2.55	V
ΔV_O	Line Regulation	$I_O = 0 \text{ mA}$ $V_I = 4.1$ to $18V$ $T_J = 25^\circ C$		0.2	4	mV
		$I_O = 0 \text{ mA}$ $V_I = 4.1$ to $18V$		0.4	4	mV
ΔV_O	Load Regulation	$I_O = 0$ to $1.5A$ $T_J = 25^\circ C$		0.5	8	mV
		$I_O = 0$ to $1.5A$		1	16	mV
V_d	Dropout Voltage	$I_O = 1.5A$		1.3	1.5	V
I_q	Quiescent Current	$V_I \leq 30V$		5	10	mA
I_{sc}	Short Circuit Current	$V_I - V_O = 5V$	1.5	2		A
		$V_I - V_O = 25V$	0.05	0.2		A
	Thermal Regulation	$T_A = 25^\circ C$, 30ms pulse		0.008	0.04	%/W
SVR	Supply Voltage Rejection	$f = 120 \text{ Hz}$, $C_O = 25 \mu F$, $I_O = 1.5A$ $V_I = 7.5 \pm 3V$	60	81		dB
eN	RMS Output Noise Voltage (% of V_O)	$T_A = 25^\circ C$ $f = 10\text{Hz}$ to 10KHz		0.003		%
S	Temperature Stability			0.5		%
S	Long Term Stability	$T_A = 125^\circ C$ 1000Hrs		0.5		%

NOTE 1: See short-circuit current curve for available output current at fixed dropout.

Table 7: Electrical Characteristics Of LD1086#285 ($V_I=5.85V$, $C_I = C_O=10\mu F$, $T_A = -40$ to $125^\circ C$, unless otherwise specified.)

Symbol	Parameter	Test Conditions	Min.	Typ.	Max.	Unit
V_O	Output Voltage (note 1)	$I_O = 0 \text{ mA}$ $T_J = 25^\circ C$	2.821	2.85	2.879	V
		$I_O = 0$ to $1.5A$ $V_I = 4.5$ to $30V$	2.793	2.85	2.907	V
ΔV_O	Line Regulation	$I_O = 0 \text{ mA}$ $V_I = 4.5$ to $18V$ $T_J = 25^\circ C$		0.2	6	mV
		$I_O = 0 \text{ mA}$ $V_I = 4.5$ to $18V$		0.5	6	mV
ΔV_O	Load Regulation	$I_O = 0$ to $1.5A$ $T_J = 25^\circ C$		1	12	mV
		$I_O = 0$ to $1.5A$		2	20	mV
V_d	Dropout Voltage	$I_O = 1.5A$		1.3	1.5	V
I_q	Quiescent Current	$V_I \leq 30V$		5	10	mA
I_{sc}	Short Circuit Current	$V_I - V_O = 5V$	1.5	2		A
		$V_I - V_O = 25V$	0.05	0.2		A
	Thermal Regulation	$T_A = 25^\circ C$, 30ms pulse		0.01	0.04	%/W
SVR	Supply Voltage Rejection	$f = 120 \text{ Hz}$, $C_O = 25 \mu F$, $I_O = 1.5A$ $V_I = 7.85 \pm 3V$	60	80		dB
eN	RMS Output Noise Voltage (% of V_O)	$T_A = 25^\circ C$ $f = 10\text{Hz}$ to 10KHz		0.003		%
S	Temperature Stability			0.5		%
S	Long Term Stability	$T_A = 125^\circ C$ 1000Hrs		0.5		%

NOTE 1: See short-circuit current curve for available output current at fixed dropout.

Table 8: Electrical Characteristics Of LD1086#33 ($V_I=6.3V$, $C_I = C_O=10\mu F$, $T_A = -40$ to $125^\circ C$, unless otherwise specified.)

Symbol	Parameter	Test Conditions	Min.	Typ.	Max.	Unit
V_O	Output Voltage (note 1)	$I_O = 0 \text{ mA}$ $T_J = 25^\circ C$	3.267	3.3	3.333	V
		$I_O = 0$ to $1.5A$ $V_I = 4.9$ to $30V$	3.234	3.3	3.366	V
ΔV_O	Line Regulation	$I_O = 0 \text{ mA}$ $V_I = 4.9$ to $18V$ $T_J = 25^\circ C$		0.5	6	mV
		$I_O = 0 \text{ mA}$ $V_I = 4.9$ to $18V$		1	6	mV
ΔV_O	Load Regulation	$I_O = 0$ to $1.5A$ $T_J = 25^\circ C$		1	10	mV
		$I_O = 0$ to $1.5A$		7	25	mV
V_d	Dropout Voltage	$I_O = 1.5A$		1.3	1.5	V
I_q	Quiescent Current	$V_I \leq 30V$		5	10	mA
I_{sc}	Short Circuit Current	$V_I - V_O = 5V$	1.5	2		A
		$V_I - V_O = 25V$	0.05	0.2		A
	Thermal Regulation	$T_A = 25^\circ C$, 30ms pulse		0.008	0.04	%/W
SVR	Supply Voltage Rejection	$f = 120 \text{ Hz}$, $C_O = 25 \mu F$, $I_O = 1.5A$ $V_I = 8.3 \pm 3V$	60	79		dB
eN	RMS Output Noise Voltage (% of V_O)	$T_A = 25^\circ C$ $f = 10\text{Hz}$ to 10KHz		0.003		%
S	Temperature Stability			0.5		%
S	Long Term Stability	$T_A = 125^\circ C$ 1000Hrs		0.5		%

NOTE 1: See short-circuit current curve for available output current at fixed dropout.

LD1086 SERIES

Table 9: Electrical Characteristics Of LD1086#36 ($V_I=6.6V$, $C_I = C_O=10\mu F$, $T_A = -40$ to $125^\circ C$, unless otherwise specified.)

Symbol	Parameter	Test Conditions	Min.	Typ.	Max.	Unit
V_O	Output Voltage (note 1)	$I_O = 0 \text{ mA}$ $T_J = 25^\circ C$	3.564	3.6	3.636	V
		$I_O = 0$ to $1.5A$ $V_I = 5.2$ to $30V$	3.528	3.6	3.672	V
ΔV_O	Line Regulation	$I_O = 0 \text{ mA}$ $V_I = 5.2$ to $18V$ $T_J = 25^\circ C$		0.5	10	mV
		$I_O = 0 \text{ mA}$ $V_I = 5.2$ to $18V$		1	10	mV
ΔV_O	Load Regulation	$I_O = 0$ to $1.5A$ $T_J = 25^\circ C$		3	15	mV
		$I_O = 0$ to $1.5A$		7	25	mV
V_d	Dropout Voltage	$I_O = 1.5A$		1.3	1.5	V
I_q	Quiescent Current	$V_I \leq 30V$		5	10	mA
I_{sc}	Short Circuit Current	$V_I - V_O = 5V$	1.5	2		A
		$V_I - V_O = 25V$	0.05	0.2		A
	Thermal Regulation	$T_A = 25^\circ C$, 30ms pulse		0.01	0.04	%/W
SVR	Supply Voltage Rejection	$f = 120 \text{ Hz}$, $C_O = 25 \mu F$, $I_O = 1.5A$ $V_I = 8.6 \pm 3V$	60	78		dB
eN	RMS Output Noise Voltage (% of V_O)	$T_A = 25^\circ C$ $f = 10\text{Hz}$ to 10KHz		0.003		%
S	Temperature Stability			0.5		%
S	Long Term Stability	$T_A = 125^\circ C$ 1000Hrs		0.5		%

NOTE 1: See short-circuit current curve for available output current at fixed dropout.

Table 10: Electrical Characteristics Of LD1086#50 ($V_I=8V$, $C_I = C_O=10\mu F$, $T_A = -40$ to $125^\circ C$, unless otherwise specified.)

Symbol	Parameter	Test Conditions	Min.	Typ.	Max.	Unit
V_O	Output Voltage (note 1)	$I_O = 0 \text{ mA}$ $T_J = 25^\circ C$	4.95	5	5.05	V
		$I_O = 0$ to $1.5A$ $V_I = 6.6$ to $30V$	4.9	5	5.1	V
ΔV_O	Line Regulation	$I_O = 0 \text{ mA}$ $V_I = 6.6$ to $20V$ $T_J = 25^\circ C$		0.5	10	mV
		$I_O = 0 \text{ mA}$ $V_I = 6.6$ to $20V$		1	10	mV
ΔV_O	Load Regulation	$I_O = 0$ to $1.5A$ $T_J = 25^\circ C$		5	20	mV
		$I_O = 0$ to $1.5A$		10	35	mV
V_d	Dropout Voltage	$I_O = 1.5A$		1.3	1.5	V
I_q	Quiescent Current	$V_I \leq 30V$		5	10	mA
I_{sc}	Short Circuit Current	$V_I - V_O = 5V$	1.5	2		A
		$V_I - V_O = 25V$	0.05	0.2		A
	Thermal Regulation	$T_A = 25^\circ C$, 30ms pulse		0.01	0.04	%/W
SVR	Supply Voltage Rejection	$f = 120 \text{ Hz}$, $C_O = 25 \mu F$, $I_O = 1.5A$ $V_I = 10 \pm 3V$	60	75		dB
eN	RMS Output Noise Voltage (% of V_O)	$T_A = 25^\circ C$ $f = 10\text{Hz}$ to 10KHz		0.003		%
S	Temperature Stability			0.5		%
S	Long Term Stability	$T_A = 125^\circ C$ 1000Hrs		0.5		%

NOTE 1: See short-circuit current curve for available output current at fixed dropout.

Table 11: Electrical Characteristics Of LD1086#80 ($V_I=11V$, $C_I = C_O=10\mu F$, $T_A = -40$ to $125^\circ C$, unless otherwise specified.)

Symbol	Parameter	Test Conditions	Min.	Typ.	Max.	Unit
V_O	Output Voltage (note 1)	$I_O = 0 \text{ mA}$ $T_J = 25^\circ C$	7.92	8	8.08	V
		$I_O = 0$ to $1.5A$ $V_I = 9.8$ to $30V$	7.84	8	8.16	V
ΔV_O	Line Regulation	$I_O = 0 \text{ mA}$ $V_I = 9.8$ to $20V$ $T_J = 25^\circ C$		1	18	mV
		$I_O = 0 \text{ mA}$ $V_I = 9.8$ to $20V$		2	18	mV
ΔV_O	Load Regulation	$I_O = 0$ to $1.5A$ $T_J = 25^\circ C$		8	30	mV
		$I_O = 0$ to $1.5A$		12	60	mV
V_d	Dropout Voltage	$I_O = 1.5A$		1.3	1.5	V
I_q	Quiescent Current	$V_I \leq 30V$		5	10	mA
I_{sc}	Short Circuit Current	$V_I - V_O = 5V$	1.5	2		A
		$V_I - V_O = 25V$	0.04	0.2		A
	Thermal Regulation	$T_A = 25^\circ C$, 30ms pulse		0.01	0.04	%/W
SVR	Supply Voltage Rejection	$f = 120 \text{ Hz}$, $C_O = 25 \mu F$, $I_O = 1.5A$ $V_I = 13 \pm 3V$	54	71		dB
eN	RMS Output Noise Voltage (% of V_O)	$T_A = 25^\circ C$ $f = 10\text{Hz}$ to 10KHz		0.003		%
S	Temperature Stability			0.5		%
S	Long Term Stability	$T_A = 125^\circ C$ 1000Hrs		0.5		%

NOTE 1: See short-circuit current curve for available output current at fixed dropout.

Table 12: Electrical Characteristics Of LD1086#90 ($V_I=12V$, $C_I = C_O=10\mu F$, $T_A = -40$ to $125^\circ C$, unless otherwise specified.)

Symbol	Parameter	Test Conditions	Min.	Typ.	Max.	Unit
V_O	Output Voltage (note 1)	$I_O = 0 \text{ mA}$ $T_J = 25^\circ C$	8.91	9	9.09	V
		$I_O = 0$ to $1.5A$ $V_I = 11$ to $30V$	8.82	9	9.18	V
ΔV_O	Line Regulation	$I_O = 0 \text{ mA}$ $V_I = 11$ to $20V$ $T_J = 25^\circ C$		1	20	mV
		$I_O = 0 \text{ mA}$ $V_I = 11$ to $20V$		2	20	mV
ΔV_O	Load Regulation	$I_O = 0$ to $1.5A$ $T_J = 25^\circ C$		8	30	mV
		$I_O = 0$ to $1.5A$		12	60	mV
V_d	Dropout Voltage	$I_O = 1.5A$		1.3	1.5	V
I_q	Quiescent Current	$V_I \leq 30V$		5	10	mA
I_{sc}	Short Circuit Current	$V_I - V_O = 5V$	1.5	2		A
		$V_I - V_O = 25V$	0.05	0.2		A
	Thermal Regulation	$T_A = 25^\circ C$, 30ms pulse		0.01	0.04	%/W
SVR	Supply Voltage Rejection	$f = 120 \text{ Hz}$, $C_O = 25 \mu F$, $I_O = 1.5A$ $V_I = 14 \pm 3V$	54	70		dB
eN	RMS Output Noise Voltage (% of V_O)	$T_A = 25^\circ C$ $f = 10\text{Hz}$ to 10KHz		0.003		%
S	Temperature Stability			0.5		%
S	Long Term Stability	$T_A = 125^\circ C$ 1000Hrs		0.5		%

NOTE 1: See short-circuit current curve for available output current at fixed dropout.

LD1086 SERIES

Table 13: Electrical Characteristics Of LD1086#12 ($V_I=15V$, $C_I = C_O=10\mu F$, $T_A = -40$ to $125^\circ C$, unless otherwise specified.)

Symbol	Parameter	Test Conditions	Min.	Typ.	Max.	Unit
V_O	Output Voltage (note 1)	$I_O = 0 \text{ mA}$ $T_J = 25^\circ C$	11.88	12	12.12	V
		$I_O = 0$ to $1.5A$ $V_I = 13.8$ to $30V$	11.76	12	12.24	V
ΔV_O	Line Regulation	$I_O = 0 \text{ mA}$ $V_I = 13.8$ to $25V$ $T_J = 25^\circ C$		1	25	mV
		$I_O = 0 \text{ mA}$ $V_I = 13.8$ to $25V$		2	25	mV
ΔV_O	Load Regulation	$I_O = 0$ to $1.5A$ $T_J = 25^\circ C$		12	36	mV
		$I_O = 0$ to $1.5A$		24	72	mV
V_d	Dropout Voltage	$I_O = 1.5A$		1.3	1.5	V
I_q	Quiescent Current	$V_I \leq 30V$		5	10	mA
I_{sc}	Short Circuit Current	$V_I - V_O = 5V$	1.5	2		A
		$V_I - V_O = 25V$	0.05	0.2		A
	Thermal Regulation	$T_A = 25^\circ C$, 30ms pulse		0.01	0.04	%/W
SVR	Supply Voltage Rejection	$f = 120 \text{ Hz}$, $C_O = 25 \mu F$, $I_O = 1.5A$ $V_I = 17 \pm 3V$	54	66		dB
eN	RMS Output Noise Voltage (% of V_O)	$T_A = 25^\circ C$ $f = 10\text{Hz}$ to 10KHz		0.003		%
S	Temperature Stability			0.5		%
S	Long Term Stability	$T_A = 125^\circ C$ 1000Hrs		0.5		%

NOTE 1: See short-circuit current curve for available output current at fixed dropout.

Table 14: Electrical Characteristics Of LD1086# ($V_I=4.25V$, $C_I = C_O=10\mu F$, $T_A = -40$ to $125^\circ C$, unless otherwise specified.)

Symbol	Parameter	Test Conditions	Min.	Typ.	Max.	Unit
V_O	Output Voltage (note 1)	$I_O = 10\text{mA}$ $T_J = 25^\circ C$	1.237	1.25	1.263	V
		$I_O = 10\text{mA}$ to $1.5A$ $V_I = 2.85$ to $30V$	1.225	1.25	1.275	V
ΔV_O	Line Regulation	$I_O = 10\text{mA}$ $V_I = 2.8$ to $16.5V$ $T_J = 25^\circ C$		0.015	0.2	%
		$I_O = 10\text{mA}$ $V_I = 2.8$ to $16.5V$		0.035	0.2	%
ΔV_O	Load Regulation	$I_O = 10\text{mA}$ to $1.5A$ $T_J = 25^\circ C$		0.1	0.3	%
		$I_O = 0$ to $1.5A$		0.2	0.4	%
V_d	Dropout Voltage	$I_O = 1.5A$		1.3	1.5	V
$I_{O(\text{min})}$	Minimum Load Current	$V_I = 30V$		3	10	mA
I_{sc}	Short Circuit Current	$V_I - V_O = 5V$	1.5	2.3		A
		$V_I - V_O = 25V$	0.05	0.2		A
	Thermal Regulation	$T_A = 25^\circ C$, 30ms pulse		0.01	0.04	%/W
SVR	Supply Voltage Rejection	$f = 120 \text{ Hz}$, $C_O = 25 \mu F$, $C_{ADJ} = 25 \mu F$, $I_O = 1.5A$ $V_I = 6.25 \pm 3V$	60	88		dB
I_{ADJ}	Adjust Pin Current	$V_I = 4.25V$ $I_O = 10 \text{ mA}$		40	120	μA
ΔI_{ADJ}	Adjust Pin Current Change	$I_O = 10\text{mA}$ to $1.5A$ $V_I = 2.8$ to $16.5V$ (note 1)		0.2	5	μA
eN	RMS Output Noise Voltage (% of V_O)	$T_A = 25^\circ C$ $f = 10\text{Hz}$ to 10KHz		0.003		%
S	Temperature Stability			0.5		%
S	Long Term Stability	$T_A = 125^\circ C$ 1000Hrs		0.5		%

NOTE 1: See short-circuit current curve for available output current at fixed dropout.

TYPICAL CHARACTERISTICS (unless otherwise specified $T_J = 25^\circ\text{C}$, $C_I=C_O=10\mu\text{F}$)

Figure 4: Output Voltage vs Temperature

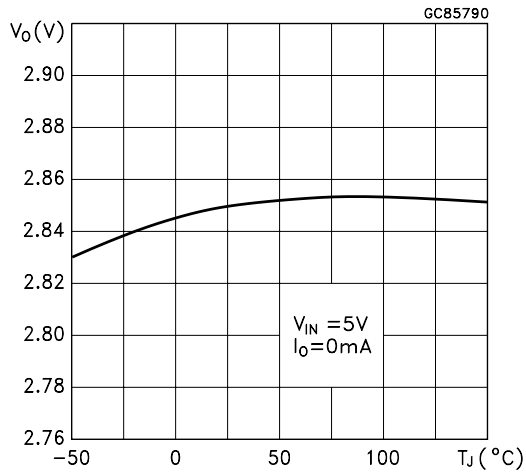

Figure 5: Output Voltage vs Temperature

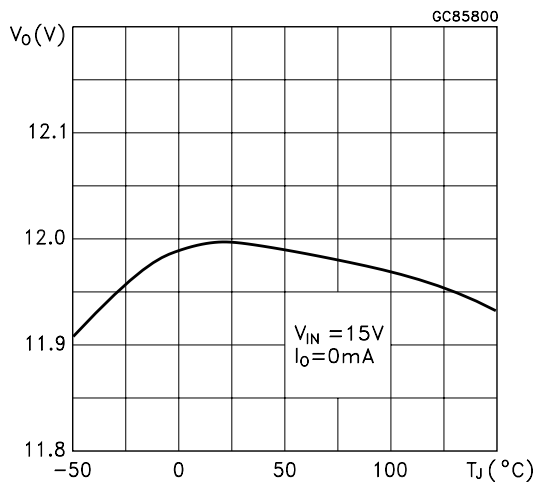

Figure 6: Output Voltage vs Temperature

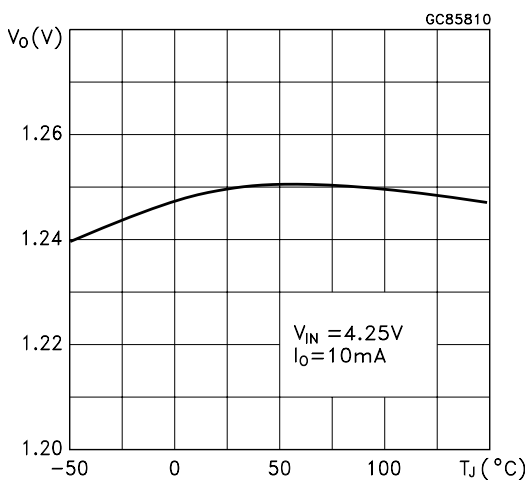

Figure 7: Short Circuit Current vs Dropout Voltage

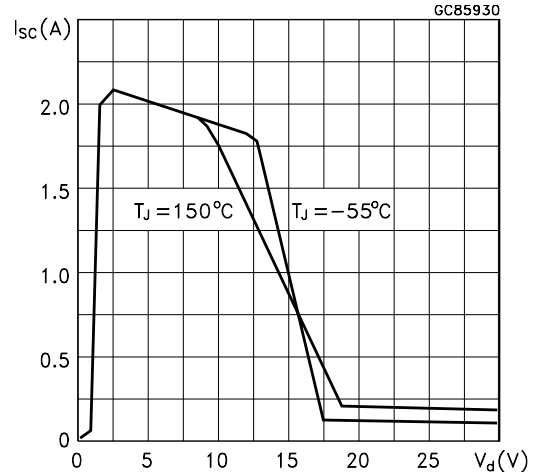

Figure 8: Line Regulation vs Temperature

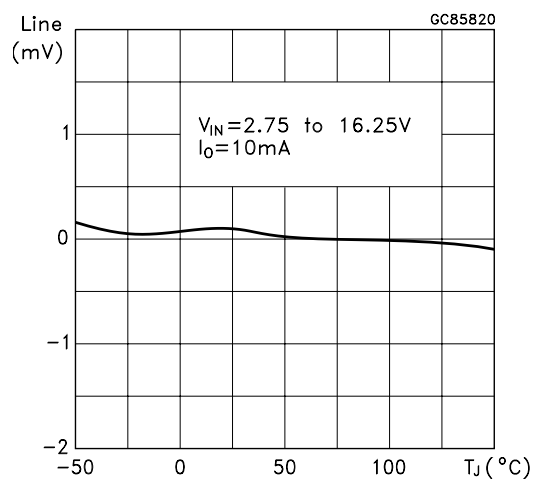

Figure 9: Load Regulation vs Temperature

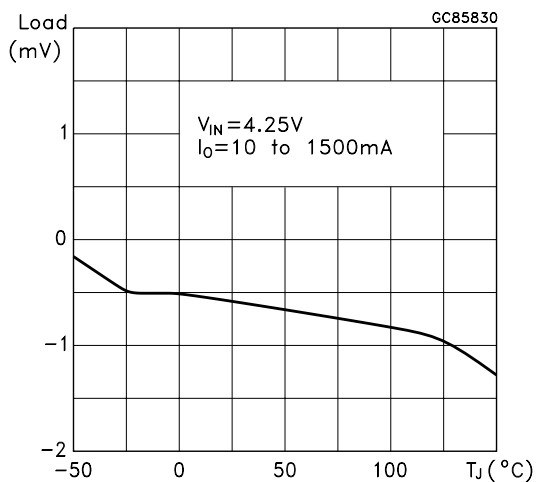

Figure 10: Dropout Voltage vs Temperature

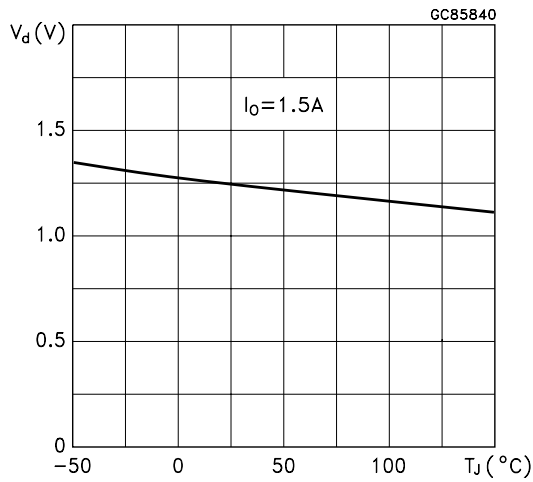

Figure 11: Dropout Voltage vs Output Current

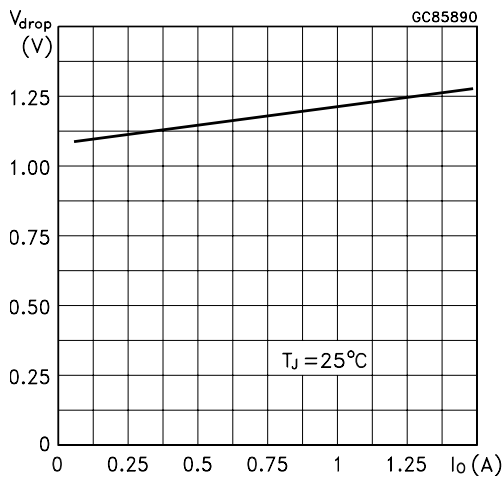

Figure 12: Adjust Pin Current vs Input Voltage

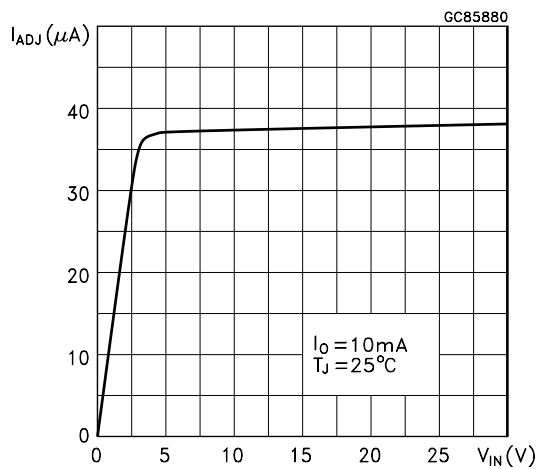

Figure 13: Adjust Pin Current vs Temperature

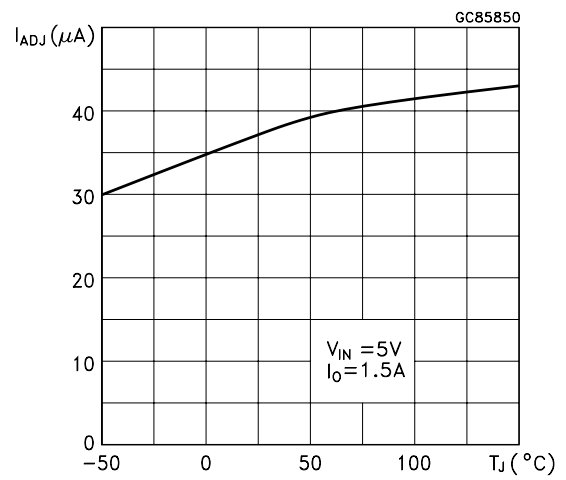

Figure 14: Adjust Pin Current vs Output Current

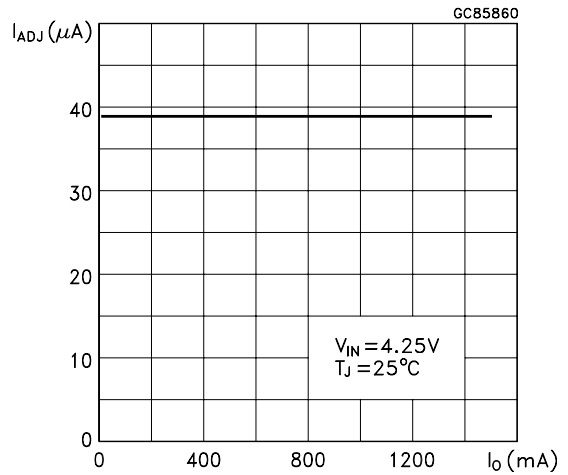

Figure 15: Quiescent Current vs Output Current

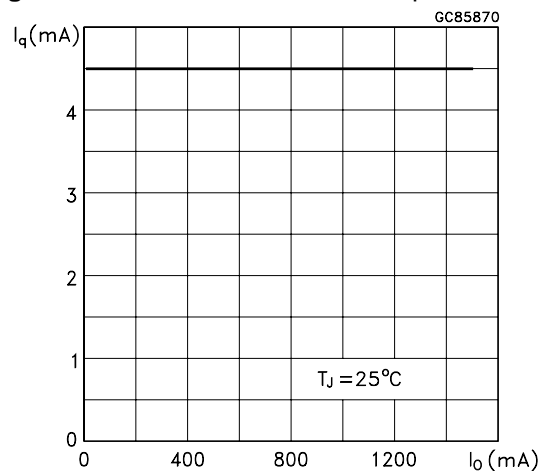

Figure 16: Quiescent Current vs Input Voltage

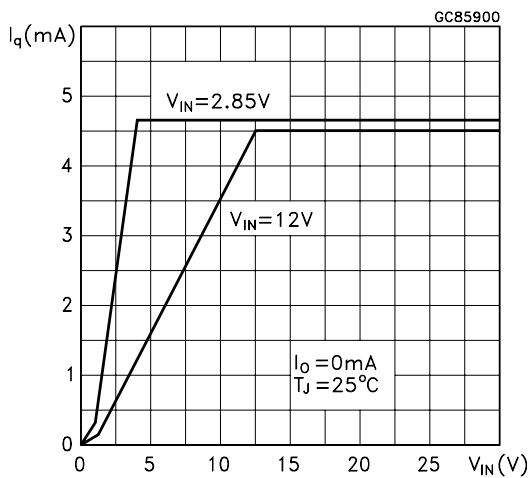

Figure 19: Supply Voltage Rejection vs Temperature

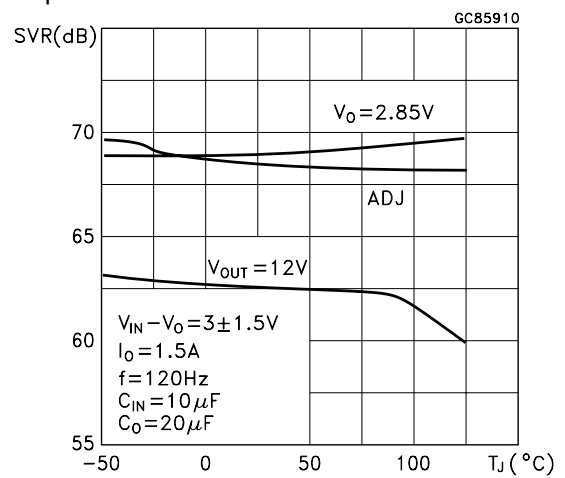

Figure 17: Supply Voltage Rejection vs Output Current

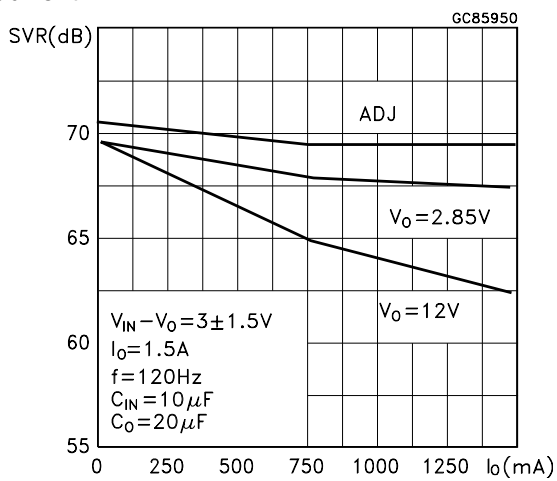

Figure 20: Minimum Load Current vs Temperature

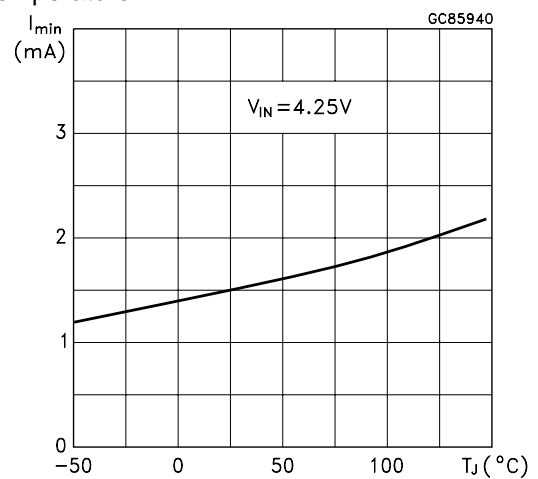

Figure 18: Supply Voltage Rejection vs Frequency

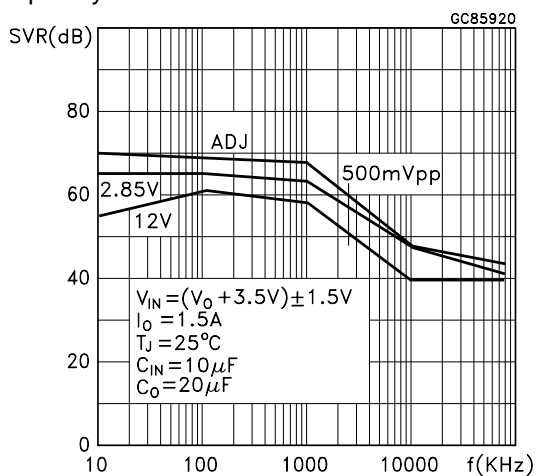

Figure 21: Stability for Adjustable

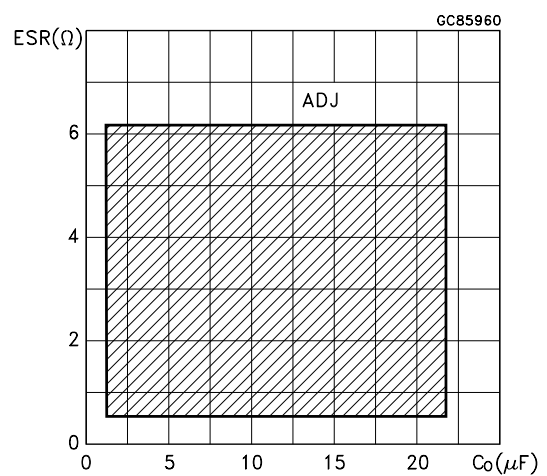

Figure 22: Stability for 2.85V

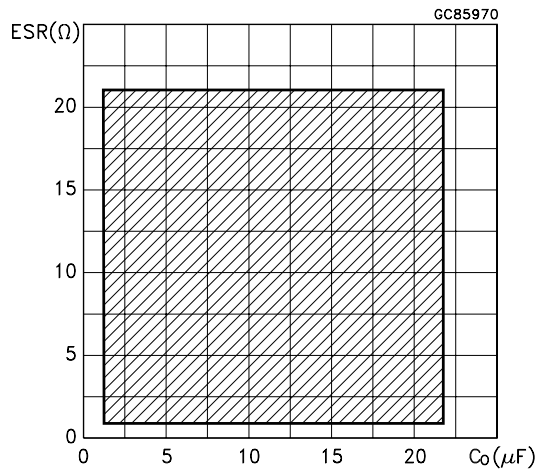

Figure 23: Stability for 12V

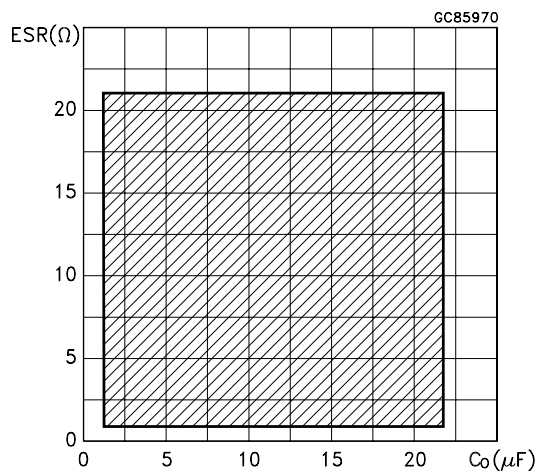

Figure 24: Line Transient

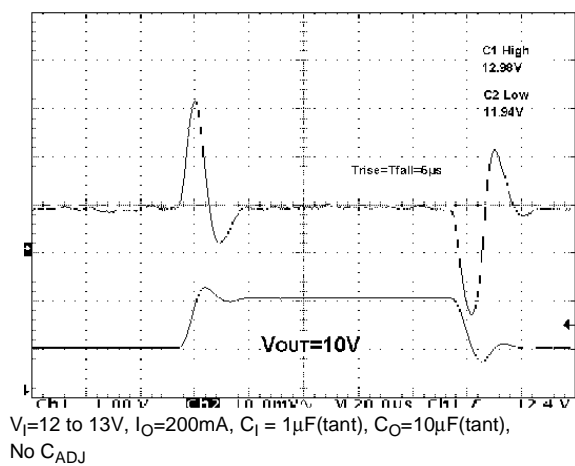

Figure 25: Line Transient

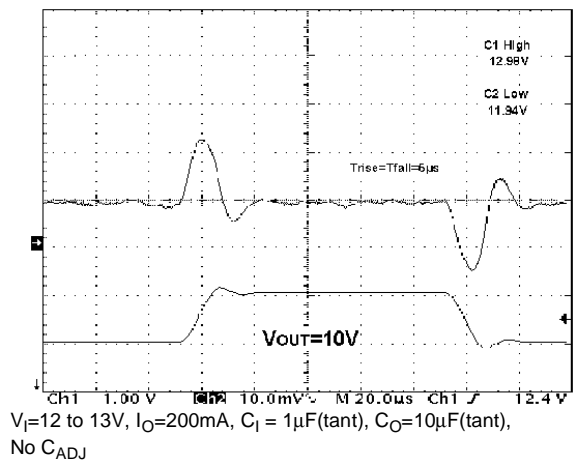

Figure 26: Line Transient

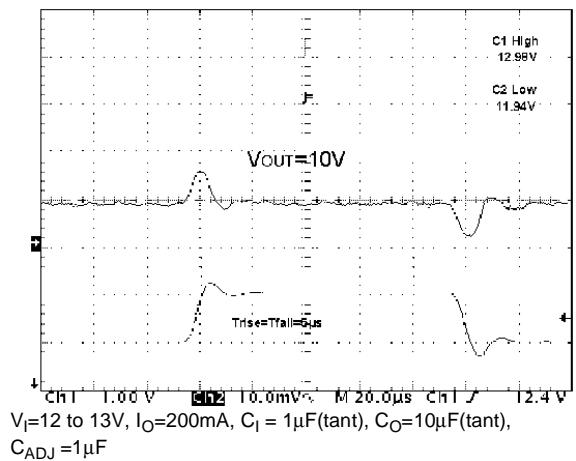

Figure 27: Load Transient

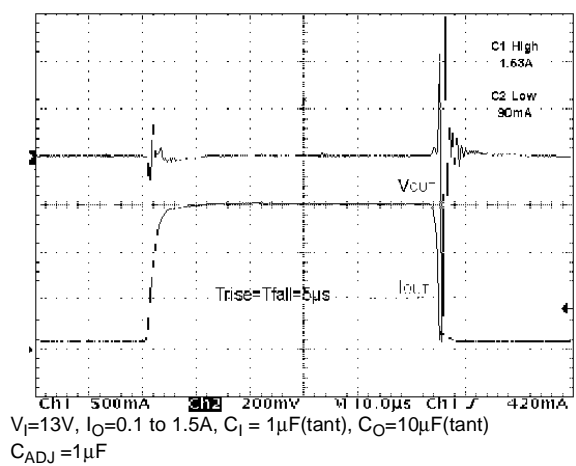

Figure 28: Load Transient

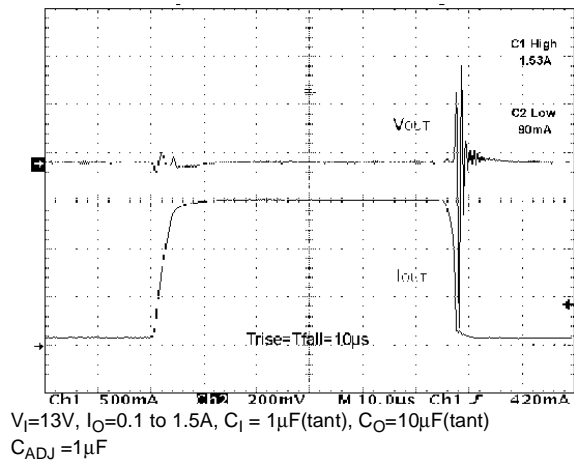
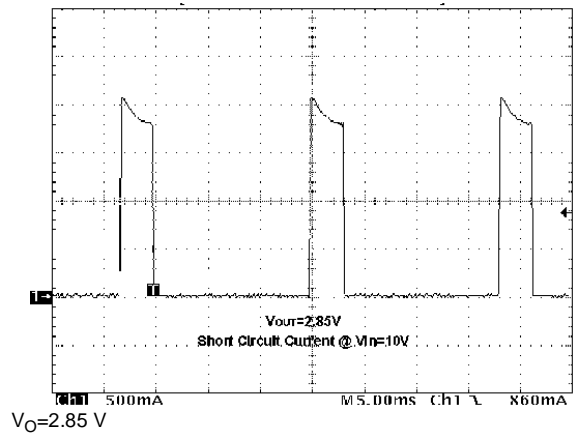
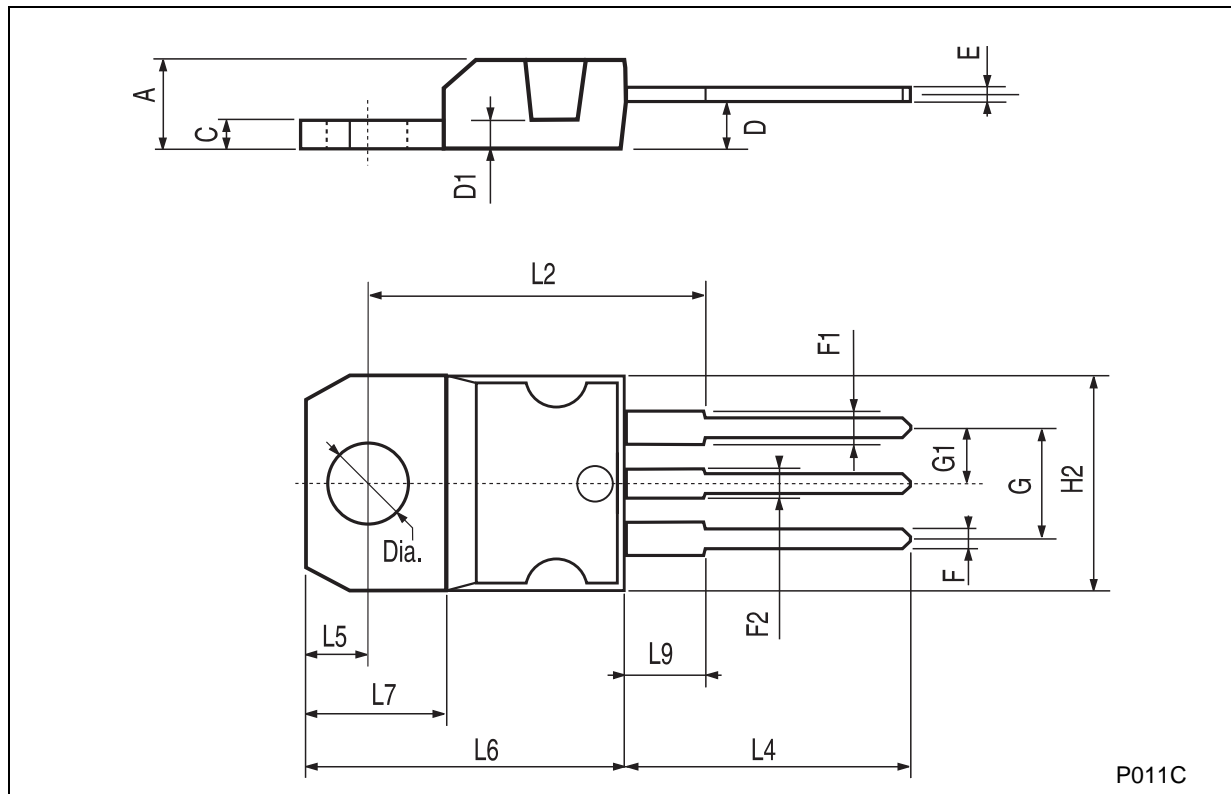

Figure 29: Thermal Protection



TO-220 MECHANICAL DATA

DIM.	mm.			inch		
	MIN.	TYP	MAX.	MIN.	TYP.	MAX.
A	4.40		4.60	0.173		0.181
C	1.23		1.32	0.048		0.051
D	2.40		2.72	0.094		0.107
D1		1.27			0.050	
E	0.49		0.70	0.019		0.027
F	0.61		0.88	0.024		0.034
F1	1.14		1.70	0.044		0.067
F2	1.14		1.70	0.044		0.067
G	4.95		5.15	0.194		0.203
G1	2.4		2.7	0.094		0.106
H2	10.0		10.40	0.393		0.409
L2		16.4			0.645	
L4	13.0		14.0	0.511		0.551
L5	2.65		2.95	0.104		0.116
L6	15.25		15.75	0.600		0.620
L7	6.2		6.6	0.244		0.260
L9	3.5		3.93	0.137		0.154
DIA.	3.75		3.85	0.147		0.151



D²PAK MECHANICAL DATA

DIM.	mm.			inch		
	MIN.	TYP	MAX.	MIN.	TYP.	MAX.
A	4.4		4.6	0.173		0.181
A1	2.49		2.69	0.098		0.106
A2	0.03		0.23	0.001		0.009
B	0.7		0.93	0.027		0.036
B2	1.14		1.7	0.044		0.067
C	0.45		0.6	0.017		0.023
C2	1.23		1.36	0.048		0.053
D	8.95		9.35	0.352		0.368
D1		8			0.315	
E	10		10.4	0.393		0.409
E1		8.5			0.335	
G	4.88		5.28	0.192		0.208
L	15		15.85	0.590		0.624
L2	1.27		1.4	0.050		0.055
L3	1.4		1.75	0.055		0.068
M	2.4		3.2	0.094		0.126
R		0.4			0.016	
V2	0°		8°	0°		8°

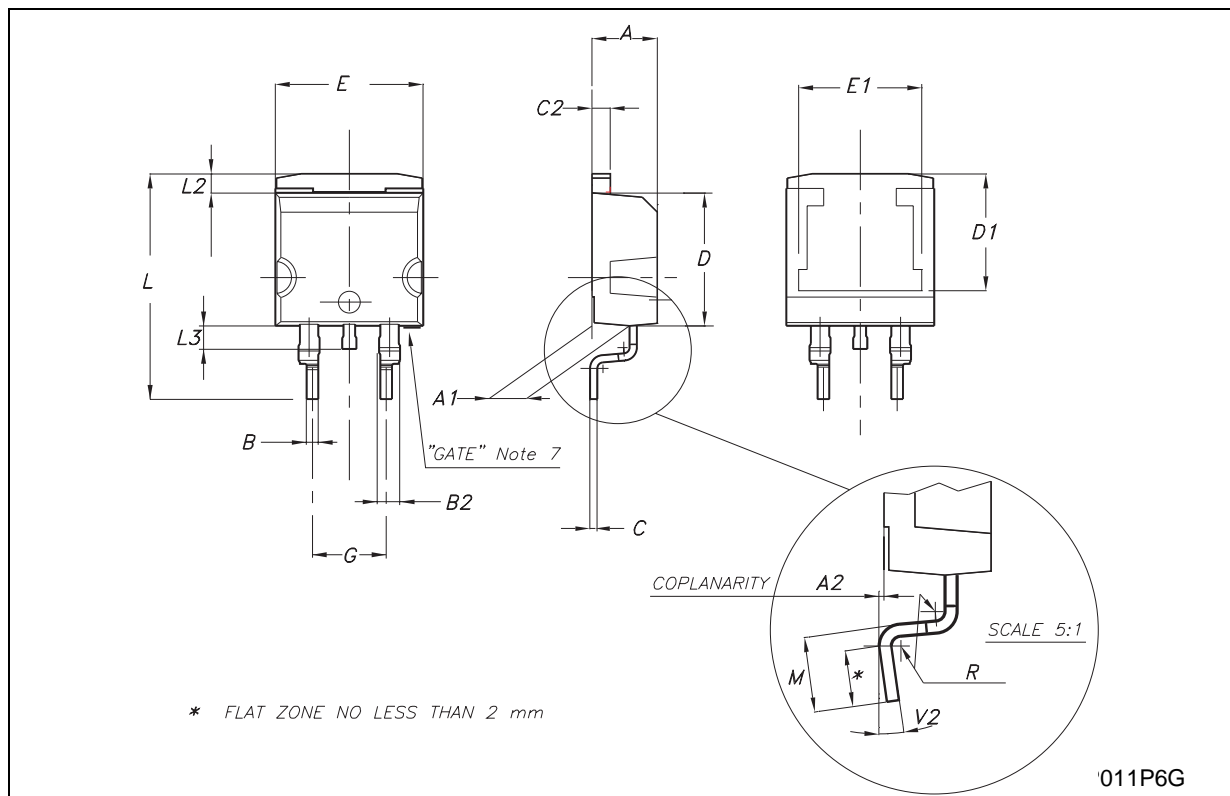

D²PAK/A MECHANICAL DATA

DIM.	mm.			inch		
	MIN.	TYP	MAX.	MIN.	TYP.	MAX.
A	4.40		4.60	0.173		0.181
A1	2.49		2.69	0.098		0.106
A2	0.03		0.23	0.001		0.009
B	0.7		0.93	0.028		0.037
B1	0.8		1.3	0.031		0.051
B2	1.14		1.7	0.045		0.067
C	0.45		0.60	0.018		0.024
C2	1.23		1.36	0.048		0.054
D	8.95		9.35	0.352		0.368
D1		8			0.315	
E	10		10.4	0.394		0.409
E1		8.5			0.335	
G	4.88		5.28	0.192		0.208
L	15		15.85	0.591		0.624
L2	1.27		1.4	0.050		0.055
M	2.4		3.2	0.094		0.126
R		0.4			0.016	
V2	0°		8°	0°		8°

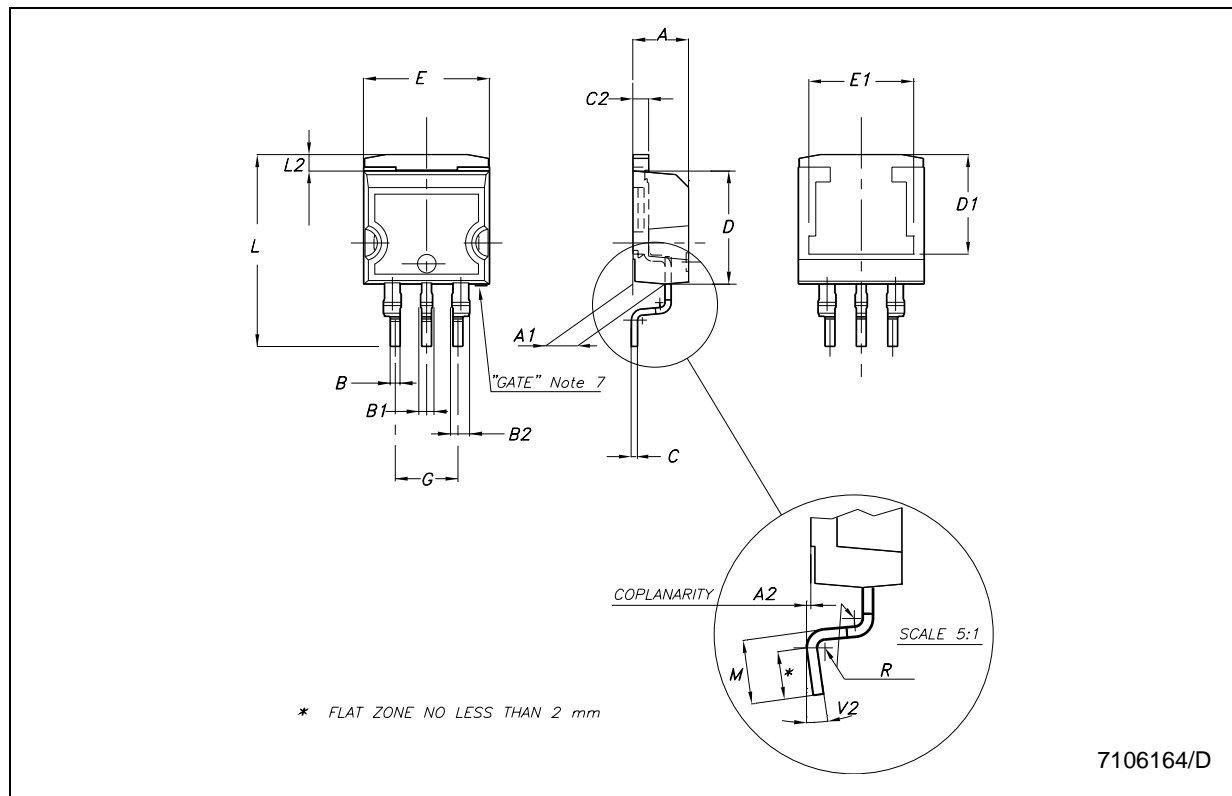

7106164/D

DPAK MECHANICAL DATA

DIM.	mm.			inch		
	MIN.	TYP	MAX.	MIN.	TYP.	MAX.
A	2.2		2.4	0.086		0.094
A1	0.9		1.1	0.035		0.043
A2	0.03		0.23	0.001		0.009
B	0.64		0.9	0.025		0.035
B2	5.2		5.4	0.204		0.212
C	0.45		0.6	0.017		0.023
C2	0.48		0.6	0.019		0.023
D	6		6.2	0.236		0.244
D1		5.1			0.200	
E	6.4		6.6	0.252		0.260
E1		4.7			0.185	
e		2.28			0.090	
e1	4.4		4.6	0.173		0.181
H	9.35		10.1	0.368		0.397
L	1			0.039		
(L1)		2.8			0.110	
L2		0.8			0.031	
L4	0.6		1	0.023		0.039

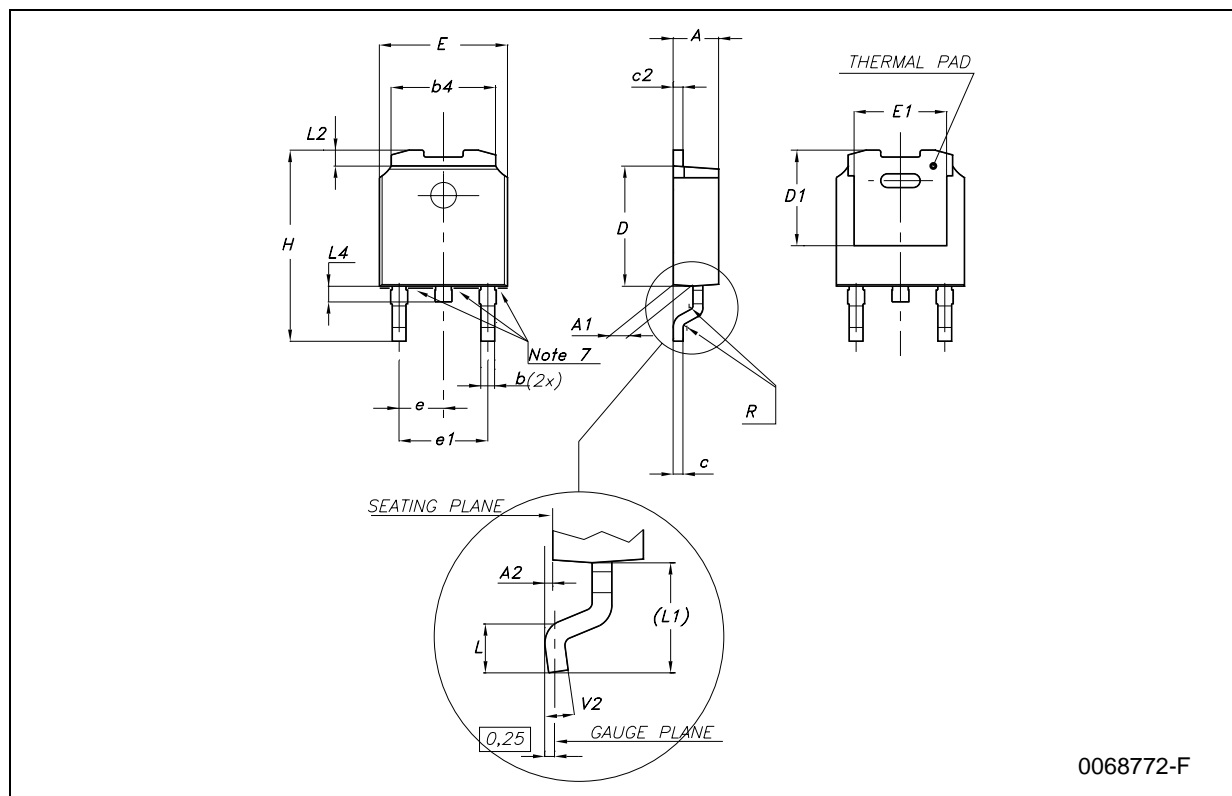

Tape & Reel DPAK-PPAK MECHANICAL DATA

DIM.	mm.			inch		
	MIN.	TYP	MAX.	MIN.	TYP.	MAX.
A			330			12.992
C	12.8	13.0	13.2	0.504	0.512	0.519
D	20.2			0.795		
N	60			2.362		
T			22.4			0.882
Ao	6.80	6.90	7.00	0.268	0.272	0.276
Bo	10.40	10.50	10.60	0.409	0.413	0.417
Ko	2.55	2.65	2.75	0.100	0.104	0.105
Po	3.9	4.0	4.1	0.153	0.157	0.161
P	7.9	8.0	8.1	0.311	0.315	0.319

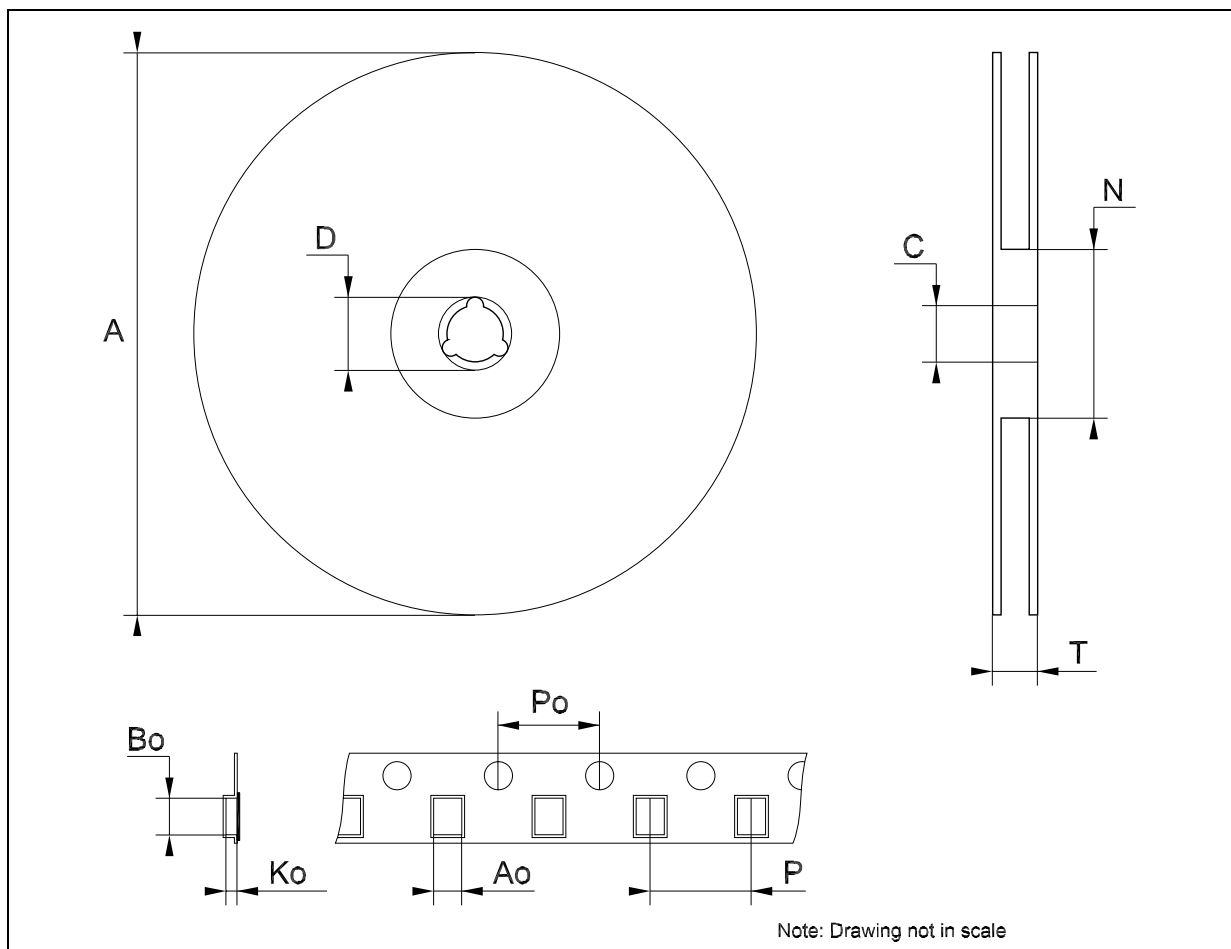

Tape & Reel D²PAK-P²PAK-D²PAK/A-P²PAK/A MECHANICAL DATA

DIM.	mm.			inch		
	MIN.	TYP	MAX.	MIN.	TYP.	MAX.
A			180			7.086
C	12.8	13.0	13.2	0.504	0.512	0.519
D	20.2			0.795		
N	60			2.362		
T			14.4			0.567
Ao	10.50	10.6	10.70	0.413	0.417	0.421
Bo	15.70	15.80	15.90	0.618	0.622	0.626
Ko	4.80	4.90	5.00	0.189	0.193	0.197
Po	3.9	4.0	4.1	0.153	0.157	0.161
P	11.9	12.0	12.1	0.468	0.472	0.476

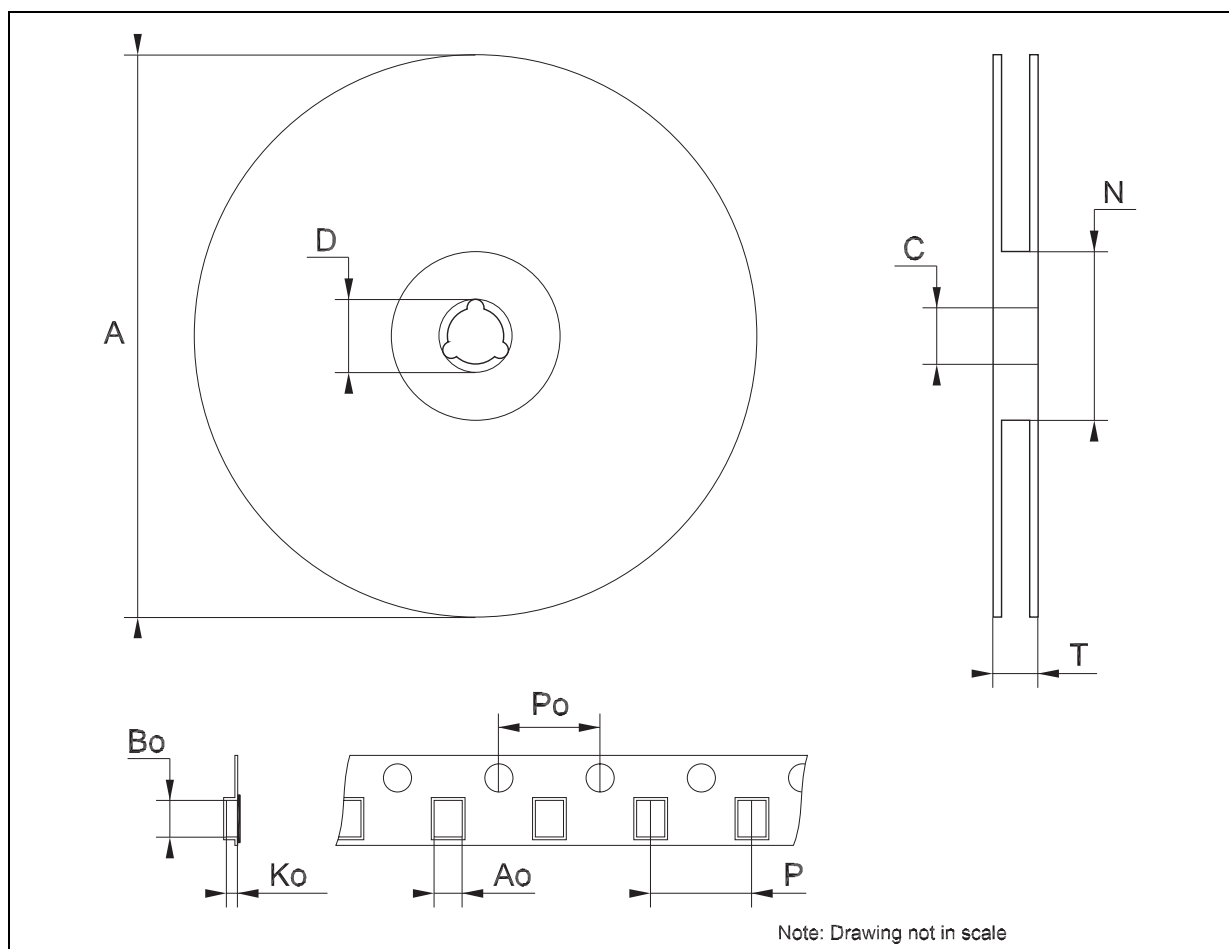

LD1086 SERIES

Table 15: Revision History

Date	Revision	Description of Changes
25-Aug-2004	11	Mistake Vo (typ.), table 9 - pag. 6.
07-Oct-2004	12	Mistake Order Codes - Table 1.
08-Feb-2005	13	Mistake U.M. Load Regulation - V ==> mV.

Information furnished is believed to be accurate and reliable. However, STMicroelectronics assumes no responsibility for the consequences of use of such information nor for any infringement of patents or other rights of third parties which may result from its use. No license is granted by implication or otherwise under any patent or patent rights of STMicroelectronics. Specifications mentioned in this publication are subject to change without notice. This publication supersedes and replaces all information previously supplied. STMicroelectronics products are not authorized for use as critical components in life support devices or systems without express written approval of STMicroelectronics.

The ST logo is a registered trademark of STMicroelectronics

All other names are the property of their respective owners

© 2005 STMicroelectronics - All Rights Reserved

STMicroelectronics group of companies

Australia - Belgium - Brazil - Canada - China - Czech Republic - Finland - France - Germany - Hong Kong - India - Israel - Italy - Japan - Malaysia - Malta - Morocco - Singapore - Spain - Sweden - Switzerland - United Kingdom - United States of America

www.st.com